

# MULTIMEDIA NAVIGATION RECEIVER

## USER MANUAL

M-DL4000



# MACROM

# Contents

---

Safety Precautions .....	1-2	Settings .....	13
Product overview .....	3	General .....	13
Remote control .....	3	Audio .....	13
Basic Operations .....	4	Time .....	13
Detect parking brake.....	4	Language .....	14
Mute .....	4	Video.....	14
Power On / Off .....	4	Volume .....	14
Adjust Volume.....	4	Calibration .....	15
Audible Beep Confirmation .....	4	SWC Programmind .....	15
Playing Source Selection .....	4	Other Modes .....	16
EQ Menu.....	5	Audio video input .....	16
Select Preset Equalizer.....	5	Replace a Fuse .....	16
Adjust EQ Parameters.....	5	Specifications .....	17-18
Adjust FAD BAL .....	5	Troubleshooting .....	19
Radio Mode .....	6	Wire Connections .....	20
Tuner TFT Display .....	6		
Select Radio as Playing Source .....	6		
Select One Radio Band.....	6		
Tune the radio.....	6		
Preset Station.....	7		
Local Seeking .....	7		
EQ Selection .....	7		
AF Function.....	7		
TA Function.....	7		
CT (Clock Time) .....	7		
PTY Function.....	7		
Playback Mode .....	8		
Touch Screen Controls .....	8		
Controlling Playback.....	8		
Connect a USB device .....	8		
Remove a USB device .....	8		
Play/Pause.....	8		
Previous/Next.....	8		
Audio playback from USB .....	8-9		
Video playback from USB.....	10-11		
Image playback from USB .....	12		
Bluetooth Mode .....	11		
Pair the Bluetooth-enabled Devices.....	11		
Disconnect Bluetooth Device.....	11		
Make a Call.....	11		
Receive a Call .....	12		
Adjust Bluetooth Settings .....	12		
Bluetooth Music Function.....	12		

# Safety Precautions

---

Thank you for purchasing this product. Please read through these operating instructions so you will know how to operate your model properly. After you've finished reading the instructions, keep this manual in a safe place for future reference.

---

Only connect the unit to a 12-volt power supply with negative grounding.

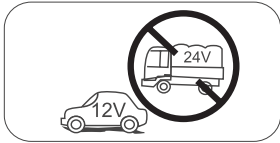

---

Never install this unit where the operation & condition for safe driving is impaired.

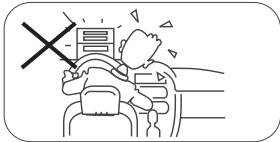

---

Never use the video display function in the front when driving to prevent the violation of laws & regulations and also to reduce the risk of traffic accident except for using rear view video camera.



---

Never expose this unit, amplifier, and speakers to moisture or water to prevent electric sparks or fire.

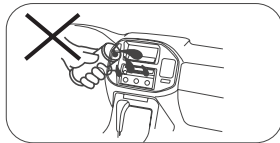

Please don't change the fuse on the power cord without professional guidance, using improper fuse may cause damage to this unit or even cause fire.

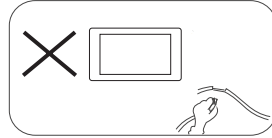

---

Please contact your nearest dealer if one of the following symptoms is experienced:

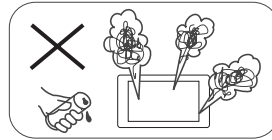

- (a). Water or other objects enters the unit.
- (b). There is smoke.
- (c). Peculiar smell.

---

To ensure safe driving, please adjust the volume to a safe and comfortable level in case of emergency situations.

## Safety Precautions

1. Never disassemble or adjust the unit without any professional guidance.  
For details, please consult any professional car shop / dealer for inquiry.
2. If the front panel or TFT monitor is dirty, please use a clean silicone cloth and neutral detergent to wipe off the spot. Using a rough cloth and non-neutral detergent such as alcohol for cleaning may result in scratching or decoloration to the monitor.
3. If any abnormal behavior of the unit is found, please refer to trouble shooting guide of this manual. If no relevant information is found, please press the [RESET] key on the front panel to resume factory default.
4. If you have parked the car in hot or cold weather for a long time, please wait until the temperature in the car becomes normal before operating the unit.
5. Using the car heater in low temperature environment may result in moisture inside the unit, DO NOT use the unit in this situation. Eject the disc and wipe off the moisture on the disc. If the unit still doesn't work after a few hours, please contact the service center.
6. Do not impact the LCD monitor which could cause damage.
7. To prevent damage to the screen, avoid touching it with sharp objects.
8. To provide a clear demonstration and an alternative for easy understanding to the operation of this unit, graphic illustrations are used.  
However, some illustrations are different from the actual images displayed on the screen.
9. Operate the unit correctly according to this manual to prevent unnecessary problem. The guarantee won't be valid if the problem is caused by inappropriate operation.

## Expanding System

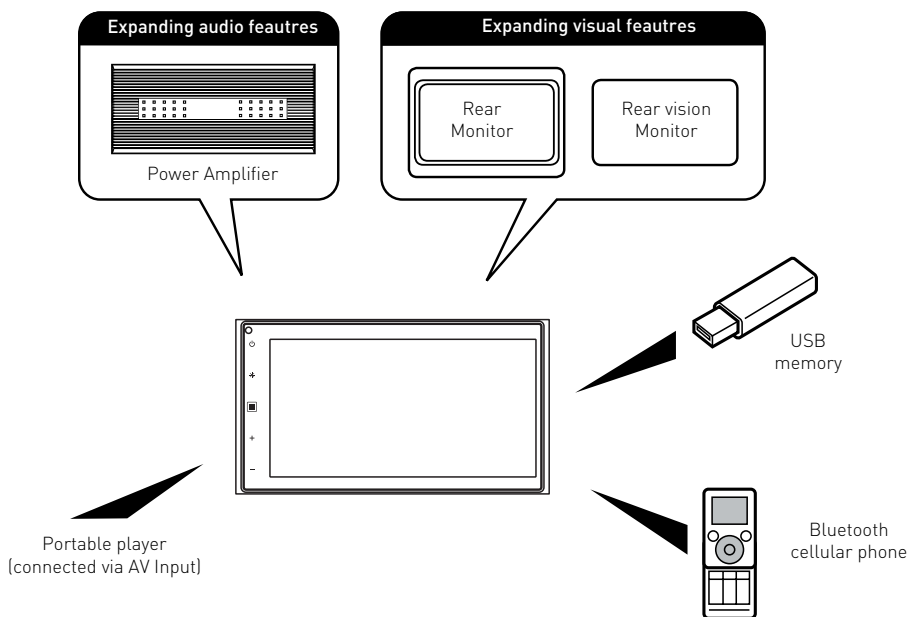

### Note:



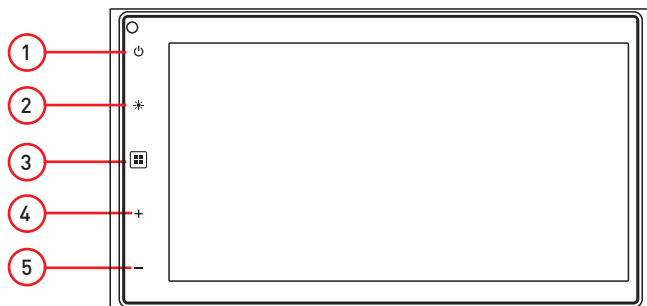

The items listed outside of the frame are the commercial products generally sold.

# Product overview

## Front Panel



Notice:  
The graphic in this manual is for reference only, and may be different from the actual unit.

1. [  ] Button  
Turn the unit on.  
Press and hold to turn the unit OFF
2. [  ] Button to adjust the brightness of screen.
3. [  ] Menu Button  
Press to display the main menu
4. [  ] Button  
Increase the volume level.
5. [  ] Button  
Decrease the volume level.

## Remote control

1. Power & Mute On/Off
2. Fast forward / Station up
3. -
4. Previous / Seek down
5. Play / Pause
6. Stop
7. Fast backward / Station down
8. Preset station [1]
9. Repeat play / Preset station [2]
10. Preset station [5]
11. Preset station [6]
12. Show main menu.
13. Preset station [3]
14. Preset station [4]
15. -
16. Adjust volume level.
17. Next / Seek up
18. Scan play / Preset scan  
Auto memory store (long press)
19. Select tuner band.

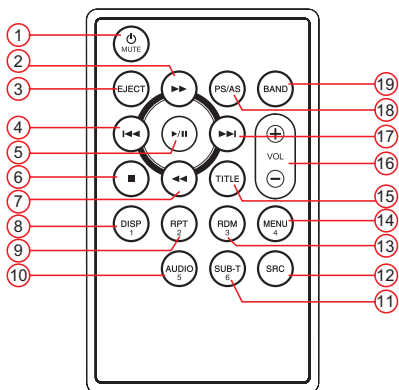

# Basic Operations

## Detect parking brake

- Connect the cable "BRAKE" to the parking brake switch to view video files on the TFT monitor. Engage the parking brake for viewing videos.
- When the parking brake is not engaged, the monitor displays "Warning!!!, Video playback is disabled for your safety. Engage parking brake to watch video.", preventing the driver to watch content while driving. The rear screens are not interested in this inhibition.

## Power On / Off

Press the [  ] button on the front panel to turn the unit ON. The buttons on the front panel light up and the current mode status appears on LCD. Press and hold the button to turn OFF the unit.

## Volume Adjustment

To increase or decrease the volume level, press the [ + ] or [ - ] button on the front panel. The volume range is from "0" to "40". The TFT screen displays the volume level for 3 seconds.

## Audible Beep Confirmation

An audible beep tone confirms each function selection. The Beep tone can be disabled through the Setup menu.

## Playing Source Selection

Press the [  ] button on the front panel to display the playing source menu.

1. Touch [ < ] oppure [ > ] to view the previous or next page of playing sources.
2. Playing source icon: touch to access corresponding work mode.
3. Time status.
4. Bluetooth status.
5. Date.



# Basic Operations

## EQ Menu

The Audio Control feature allows you to easily adjust your audio system to meet the acoustical characteristics of your vehicle, which vary depending on the type of vehicle and its measurements. Proper setting of the Fader and Balance boosts the effects of the cabin equalizer.

## Select Preset Equalizer

1. Enter the EQ setup mode  
Touch the [  ] icon in the user interface and the EQ setup interface will display on the screen.
2. Select EQ mode  
Touch the desired EQ selection: [ Optional ] / [ Classic ] / [ Rock ] / [ Jazz ] / [ Techno ] / [ Pop ], and the EQ mode will change.

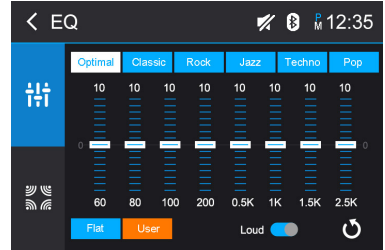

## Adjust EQ Parameters

To adjust EQ parameters, touch and drag the parameters adjustment bar.



[ User ]: Set the desired audio effect.

[ Flat ]: Select the original audio effect.

[ Loud: On/Off ]: When listening to music at low volumes, this feature will selectively boost certain bass and treble frequencies.

## Adjust FAD BAL

You can adjust front/back/left/right balance of the speaker and the subwoofer volume to get balanced listening effect according to the surroundings and your interest.

1. Enter the EQ setup mode  
Touch the [  ] icon in the user interface and the EQ setup interface will display on the screen.
2. Adjust subwoofer volume  
Touch [ ▲ ] / [ ▼ ] or drag [  ] to adjust subwoofer volume from -8 to +8.
3. Adjust fader / balance value  
Touch [ ▲ ] / [ ▼ ] / [ ◀ ] / [ ▶ ] to adjust fader / balance value from -14 to +14.  
[ ▲ ]: Front speaker  
[ ▼ ]: Rear speaker  
[ ◀ ]: Left speaker  
[ ▶ ]: Right speaker

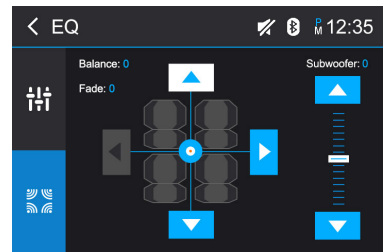

Notes:

1. The parameters of the EQ modes has been preset and you can not change them besides 'User'.
2. The EQ mode will change to 'User' automatically when you adjust the frequency value under the modes besides 'User'.
3. The value of Sub is independent of EQ mode and can be adjusted separately.

# Radio Mode

## Tuner TFT Display

1. Current radio band indicator.
2. Return to home menu.
3. Current station frequency.
4. Preset stations list.
5. Shortcut.
6. Band switch.
7. Seek backward
8. Tune backward(long press)
9. Enter frequency directly.
10. Seek forward
11. Tune forward(long press)
12. Opening the options menu.
13. Auto searching.
14. Enter EQ menu.
15. To turn On or Off "Clock Time"
16. Choose local or distant seeking mode.
17. To turn On or Off "TA" function.
18. To show PTY list.
19. To turn On or Off "AF" function.
20. Closing the options menu.

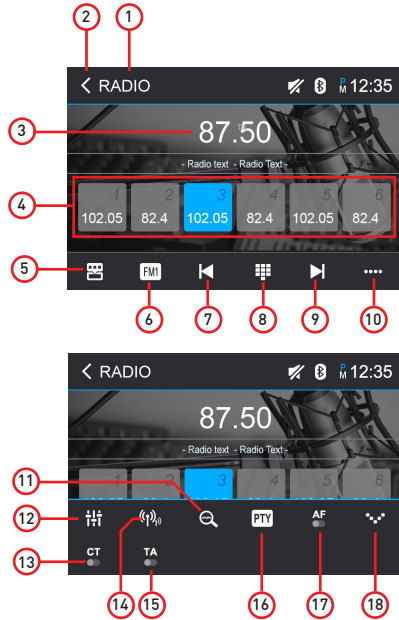

## Select Radio as Playing Source

Open the Source Menu and then touch [Radio].

## Select One Radio Band

Touch the [📶] icon on the user interface to select one radio band among FM1, FM2, FM3, AM1 and AM2.

## Tune the radio

### Auto Tunig

During auto tuning, the frequency will be changed in seek mode.

Touch the [◀] / [▶] icon on the user interface to tune in a higher / lower station.

Note: When a station is received, searching stops and the station is played.

### Manual Tuning

#### Method 1:

Touch and hold [◀] / [▶] icon on the user interface more than 1 second to changed in steps higher / lower station. Repeat the operation to change step by step.

#### Method 2:

1. Touch the numeric keypad icon [🔢].  
Numeric keyboard is displayed, touch number to input frequency.
2. Touch [⏪] to delete the input number step by step.
3. Touch [OK] to enter.



## Radio Mode

---

### Preset Station

The unit has 5 bands, such as FM1, FM2, FM3, AM1, AM2, and each band can store 6 stations; the unit can store 30 stations in total.

Search Stations Automatically

Touch [  ] to search station and store 6 strongest stations in current band automatically.

Manual Store

1. Tune to a station.
2. Touch one of the channels P1 to P6 to save the select band.

Recalling a Station

1. Select a band.
2. Touch an on-screen preset button (P1 to P6) to select the corresponding stored station.

### Local Seeking

Touch the [  ] icon and choose the Radio Local or Distance.

When the [ Distance ] icon turns bright, only stations with a strong signal strength will be detected. Default is "Distance".

### EQ Selection

Press the [  ] icon and enter the EQ setup.

### AF Function

Alternative Frequencies Lists are used in conjunction with the PI code (Program Identification code) to assist automatic tuning.

Using this information, the radio can automatically search out another frequency of the same station.

Note:

- During auto switching radio frequency, some interference may be heard..
- Turning off AF function can settle this problem.

### TA Function

The TA (Traffic Announcement) function lets the unit receive traffic announcements automatically. The TA function can be activated by a TP (Traffic Program) station broadcasting traffic information. When TA is activated and a traffic announcement is received, the current playing source will be overridden by the traffic announcement. The unit returns to the original source after the traffic announcement has been received.

### CT (Clock Time)

Some stations broadcast the time and date within the encoded RDS signal. The clock time is automatically adjusted when 'CT' is set to 'ON'.

### PTY Function

PTY is an abbreviation for the type of program defined by a code to define the program being broadcast (eg news or Rock).

The Options of PTY is displayed on the screen. To see the options PTY, tap the scroll bar and arrows on the screen.

When an option is selected PTY (eg News), the radio unit, the PTY search available. If the PTY requested was not found, the unit returns to the original radio frequency.

# Playback Mode

## Touch Screen Controls

The touch key areas for image/video playback are outlined below:

- A: Return to the main menu
- B: Disc type
- C: Play the video and display playback information
- D: Time display
- E: Display onscreen control menu

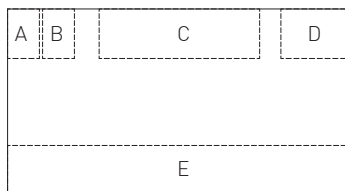

## Controlling Playback

To access the on-screen controls, touch the screen except upper left corner, and touch again to cancel display. Touch [••••] to view all function icons.

## Connect a USB device

1. Connect an USB device into the rear USB connector.  
Play starts automatically.

## Remove a USB device

1. Select another source in the main menu.
2. Remove the USB device.

## Play/Pause

1. Once USB device is inserted, play starts automatically.  
For movie, if a menu appears, press [▶] to start play.
2. To pause, touch [⏸].  
To resume play, touch [▶].
3. Skip to previous / next track / chapter, press [⏮] / [⏭] key.

## Previous/Next

Touch [⏮] / [⏭] key on the screen to skip to previous / next track / chapter.

## Audio playback from USB

The principles of audio playback (MP3/WMA) from data carriers are identical for all sources. Select the desired source via the main menu.

The device changes to the desired source and the playback starts.

If the playback does not start with the audio playback, touch the [☰] icon to change to the folder/file list.

Touch the [🔒] icon to display all the folders and files of the data carrier.

- Or -

Press the [🎵] icon to display all the audio files of the data carrier.

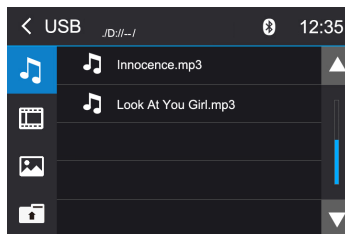

# Playback Mode

## Audio playback from USB

After starting a title, the playback menu is displayed.

1. Shortcut.
2. Display the folder/file list.
3. Short press: Previous track.  
Long press: Fast backward.
4. Pause playback and continue playback.
5. Short press: Next track.  
Long press: Fast forward.

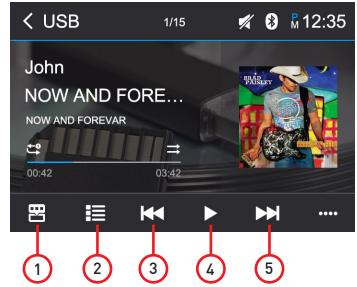

Tap on [••••] to display additional operating options of the playback menu.

6. Display equalizer.
7. Start and end REPEAT function.  
Repeat mode:  
Repeat One  Repeat Folder  Repeat All  Repeat Off
8. Shuffle playback.
9. Display keypad to directly enter the number of the desired title.

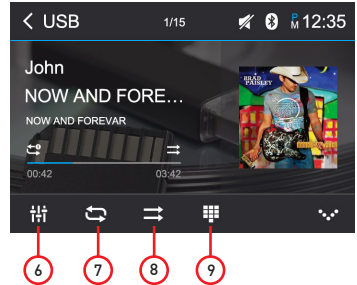

## Video playback from USB

Select the desired source via the main menu.

The device changes to the desired source and the playback starts.

If the playback does not start with the video playback, touch the [≡] icon to change to the folder/file list.

Touch the [📁] icon to display all the folders and files of the data carrier.

- Or -

Touch the [📺] icon to display all the audio files of the data carrier.

If you selected a movie, the playback is started. During the movie playback, the playback menu is hidden.

Briefly touch the screen once to display the playback menu again.

The playback menu is shown.

1. Shortcut.
2. Display the folder/file list.
3. Short press: Previous movie.  
Long press: Fast backward.
4. Pause playback and continue playback.
5. Short press: Next movie.  
Long press: Fast forward.

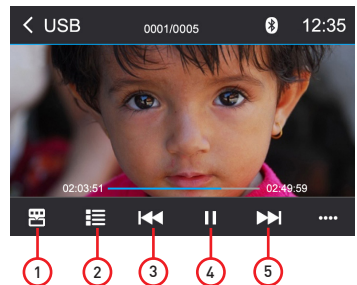

# Playback Mode

## Video playback from USB

Tap on [••••] to display additional operating options of the playback menu.

6. Select playback language.
7. Display equalizer.
8. Start and end REPEAT function.  
Repeat mode:  
Repeat One → Repeat Folder → Repeat All → Repeat Off
9. Adjust the brightness, contrast, and saturation.
10. Display keypad to directly enter the number of the desired title.
11. Select playback audio channel.

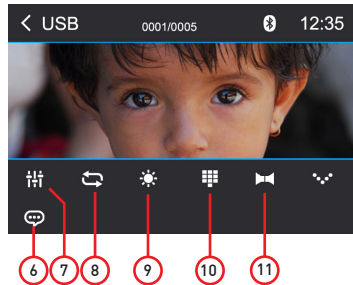

## Image playback from USB

Select the desired source via the main menu.

The device changes to the desired source and the playback starts.

If the playback does not start with the image playback, touch the [☰] icon to change to the folder/file list.

Touch the [📁] icon to display all the folders and files of the data carrier.

- Or -

Touch the [🖼️] icon to display all the images of the data carrier.

If you selected a image, the playback is started. During the playback, the playback menu is hidden.

Briefly touch the screen once to display the playback menu again.

The playback menu is shown.

1. Shortcut.
2. Display the folder/file list.
3. Previous image.
4. Pause playback and continue playback.
5. Next image.

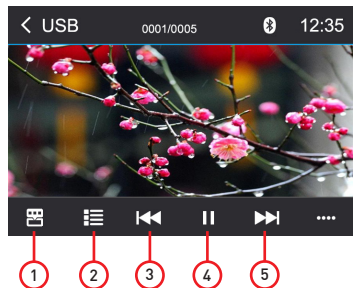

Tap on [••••] to display additional operating options of the playback menu.

6. Zoom in/out.
7. Rotate images .
8. Adjust the brightness, contrast, and saturation.
9. Display keypad to directly enter the number of the desired title.

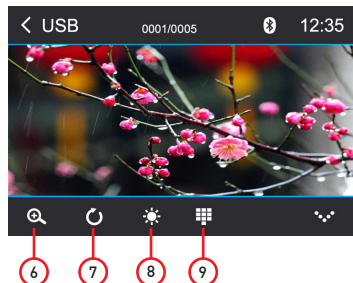

# Bluetooth Mode

You can make or receive phone calls with Bluetooth-enabled phones through the unit. You can also listen to music from a Bluetooth-enabled device.

## Pair the Bluetooth-enabled Devices

To connect your Bluetooth device to the unit, you need to pair the device to the unit. Pairing needs only to be done once. You can pair up to five devices.

1. Turn on the Bluetooth function on the device.
2. Touch [🔍] to search for Bluetooth device with the unit.
3. Start scanning on the Bluetooth device and select the unit "M-DL4000"
4. Enter default password "0000".

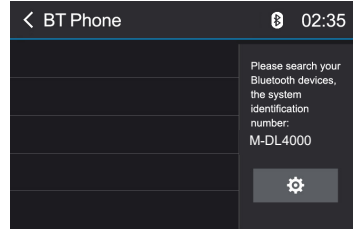

Tip:

- The operational range between this unit and a Bluetooth device is approximately 5 meters .
- Before you connect a Bluetooth device to this unit, familiarize yourself with the Bluetooth capabilities of the device.
- Compatibility with all Bluetooth device is not guaranteed.
- Any obstacle between this unit and a Bluetooth device can reduce the operational range.
- Keep this unit away from any other electronic device that may cause interference.

## Disconnect Bluetooth Device

To disconnect one device, touch [🔌]. After pressed, the unit will display a screen listing paired devices. Pressing the Green "Plug" icon will reconnect a previously paired phone to the BT radio. Pressing the "Wastebin" icon next to a device's name will unpair the phone from the unit.

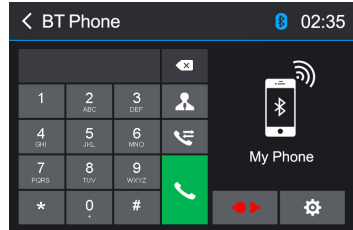

NOTES

- The device will be disconnected when the device is moved beyond the operational range.
- If you want to reconnect the device to the unit, place it within the operational range.
- If you do not want to reconnect the device to the unit automatically, touch [⚙️], then set [ Auto Connect ] to [ OFF ].

## Make a Call

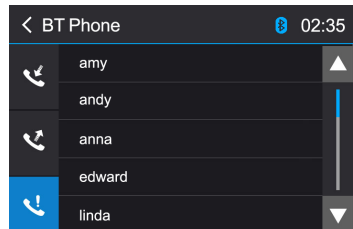

1. Select Bluetooth function in the home menu.
2. On Option page, see the "Phone Synch" item, and press "Synch" to synchronize the phone book with the BT. If you have many contacts, this may take up to 3-4 minutes.
3. Search for phone number from the following list:
  - [Phone Book]
  - [Call History]
  - [Missed calls]
  - [Received calls]
  - [Dialed calls]



## Bluetooth Mode

### Receive a Call

By default, all incoming calls are received automatically.

1. If there is an incoming call, the screen will display incoming call number.
2. Touch the screen to select [  ] or [  ].  
Speak into the Bluetooth microphone.

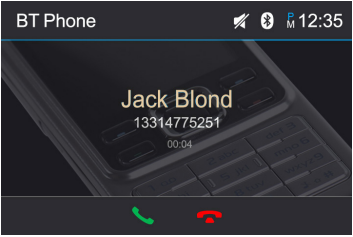

NOTE:

- You can select to receive calls manually by setting [Auto Answer] to [OFF]

### Adjust Bluetooth Settings

In the options menu for Bluetooth, you can make the basic settings for the Bluetooth mode.

Touch the [  ] icon.

The options menu is displayed.

Bluetooth:

To turn the "Bluetooth" function ON or OFF.

Auto Connect:

To turn the "Auto Connect" function ON or OFF.

Auto Answer:

To turn the "Auto Answer" function ON or OFF.

Pin Code:

To set the pairing code.

Phone Synch:

To synchronize phone book, touch [ OK ] on the sub-menu

Phonebook Synch may take several minutes to load on initial setup.

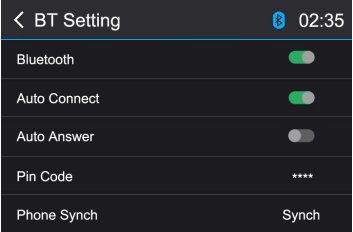

### Bluetooth Music Function

Bluetooth provides an Advanced Audio Distribution Profile (A2DP) profile for streaming music from a mobile phone, sometimes referred to as a MP3 player. The unit allows you to play back audio files from your mobile phone using a Bluetooth connection.

1. Shortcut.
2. Previous track.
3. Pause playback and continue playback.
4. Disconnect connection with current device.
5. Next track.
6. Display equalizer.

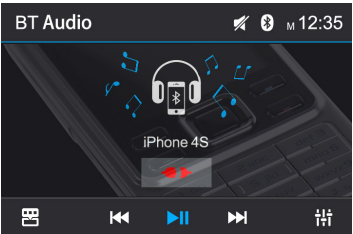

NOTE:

When playing music via Bluetooth, if you want to make a call, you can press the number buttons on your phone. From that moment on, the music player stops. The TFT screen will display "Connection" during the call, audio will be transferred to the unit. At the end of the call, the screen will display the music playback menu.

If there is an incoming call, the music player stops, and the screen will show "Incoming Call". At the end of the call, the screen will display the music playback menu.

# Settings

## General Settings

1. Touch [  ], if necessary.
2. Touch to highlight a setting to display/select an option.

General Settings	Options	Description
Radio Region	USA/Asia/Japan/Europe/Europe LW/Oirt	Select one that matches your location.
Radio Range	Distance	Select Local to receive only stations with extremely strong signal.
	Local	
Beep	On	Turn-ON the beep sound. Each time you press a button, the unit beeps.
	Off	Turn-OFF the beep sound.
Calibration	Start	Calibrate the touch screen.
Shortcut	Set the shortcut.	
SWC	Enter to SWC interface	
Load Factory	Restore to default settings.	
UI Color	Change the color of the UI.	





## Audio Settings

1. Touch [  ].
2. Touch an option repeatedly to select.

Audio Settings	Options	Description
Subwoofer	On	Turn On the subwoofer.
	Off	Turn Off the subwoofer
Subwoofer Filter	80Hz	Select a crossover frequency to set a cut-off frequency for the subwoofer's LPF (low-pass filter).
	120Hz	
	160Hz	
Loudness	On	Turn On the loudness
	Off	Turn Off the loudness
L o u d n e s s Center	400Hz	Select loudness center frequency.
	800Hz	
	2.4KHz	

## Time Settings

1. Touch [  ].
2. Touch an option repeatedly to select.

Time Settings	Options	Description
Date	Y/M/D	Touch [  ] or [  ] to set year, month and day.
Clock Format		Touch [ 24Hr ] or [ 12Hr ] to switch clock mode.
Time	H/M	Touch [  ] or [  ] to set hour and minutes.

Note:

When date/time is set, touch [ **Save** ] to confirm or [ **Cancel** ] to exit.

# Settings

## Language Settings

1. Touch [  ].
2. Touch an option repeatedly to select.

Language Settings	Description
OSD Language	Select on-screen display language.

## Video Settings

1. Touch [  ].
2. Touch an option repeatedly to select.

Video Settings	Options	Description
Aspect Ratio	Full	Adjust aspect ratio.
	Normal	
Parking	On	Disable video when driving.
	Off	Enable video when driving.
Adjust	Enter	Touch [ + ] or [ - ] to adjust brightness, contrast and saturation.
Version Info	Enter	Display the current version information

## Adjust Volume Settings

You can set different volumes for different sources.

1. Touch the [  ] icon to display and access the volume setting sub-menu
2. Touch the source to be adjusted.
3. The volume range is from "00" to "06"  
When switching to the source, the volume increases automatically.
4. Touch blank area to close the sub-menu and touch the upper left corner icon [ < ] to exit setting menu.



# Settings

## Calibration

When the touch operation is not sensitive or valid, you should calibrate the touch screen using the calibration setting function. Adjust the response positions of the touch panel as follows:

1. Touch [ Start ] to enter.
2. Touch [ Cancel ] to exit.
3. Press and hold the center of [ + ] for 2 seconds, the [ + ] will move automatically.
4. Aim at center of [ + ], follow the path as shown in the figure. Once steps 1-5 are complete, touch [ OK ] to exit calibrating mode.

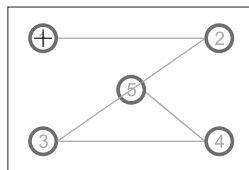

## SWC Programming

The following controls are available for most vehicles:

1	2	3	4	5	6
Volume +	Volume -	Mute	Next	Prev	Play
7	8	9	10	11	12
Home	Preset +	Preset -	Band	Source	Answer

Touch [ Enter ], the SWC menu will display.

Up to 12 steering wheel control functions can be programmed via the built-in SWC interface. Not all functions may be supported for each vehicle.

1. Before programming, you need to clear / reset the SWC interface by pressing the [Reset] icon.
2. Define the functions of the steering wheel controls by pressing a number 1 ~ 12, then press a function between the available ones. A check mark corresponding to the number and function will be displayed. Repeat the confusion until completing all the steering wheel control functions.

Note:

Define only the functions available on the steering wheel.

3. To complete the programming, tap the [Program] icon. It will then be required to push each button on the OE wheel (for 1 second), so that the unit can store the corresponding function.
4. SWC learning / programming is now complete.
5. Touch [ < ] to exit.

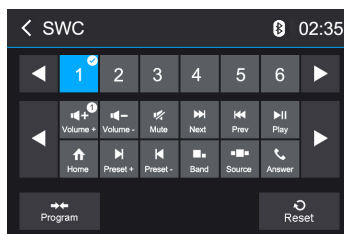

## Other Modes

---

### Audio video input

#### Audio video

A/V input is used for playback of audio/video from an external device connected through RCA connectors located on the back of the unit.

1. Connect the external device with the supplied A/V cable.
2. Touch the upper left corner to display the main menu.
3. Touch [AV] to access external device.

Notes:

1. Audio/Video device must be connected to the unit using an audio/video adapter cable that is available separately.
2. Video will only play when the vehicle parking brake is engaged. The parking brake must be connected for this feature to operate.

### Replace a Fuse

If there is no power, the fuse may be damaged and need to be replaced.

1. Take out the unit from dashbord.
2. Check all electrical connections.
3. Buy a fuse that matches the amperage of the damaged fuse.
4. Replace the fuse while the units power is disconnected.

# Specifications

---

## General

Reference Supply Voltage .....	12V(DC)
Operating Voltage Range .....	10.5 - 15.8V(DC)
Max Operating Current .....	15A
Grounding System .....	Car Battery Negative Pole
Dimensions(WXHXD) .....	178.5X101.5X166mm
Weight(main unit) .....	1.8kg

## FM

Signal Noise Ratio .....	≥55dB
Residual Noise Sensitivity (S/N=30dB) .....	18dB $\mu$ V
Frequency Response ( $\pm$ 3dB) .....	20Hz~12.5KHz
Station Seeking Level .....	20~28dB $\mu$ V
Distortion .....	≤1.0%
Stereo Separation (1KHz) .....	≥25dB
Antenna Impedance.....	75 $\Omega$

## AM

Residual Noise Sensitivity (S/N=20dB) .....	35dB $\mu$ V
Selectivity ( $\pm$ 9KHz) .....	≥50dB

## LCD

Screen size.....	6.2 inches(16:9)
Display resolution.....	800X480dots

## Power output

Distortion (line out).....	≤0.1%
Frequency Response ( $\pm$ 3dB) .....	20Hz~20KHz
Maximum Output Power .....	4×50W
Load Impedance .....	4 $\Omega$

## AUX IN

Distortion .....	≤0.5%
Frequency Response ( $\pm$ 3dB) .....	20Hz~20KHz
Audio Input Level .....	0.5Vrms

## Audio

Audio Output Impedance .....	100 $\Omega$
Audio Output Level .....	3Vrms(Max)

## Video

Normal Video Input Level (CVBS) .....	1.0 $\pm$ 0.2V
Video Input Impedance .....	75 $\Omega$
Video Output Impedance .....	75 $\Omega$
Video Output Level.....	1.0 $\pm$ 0.2V

## Environment

Operating Temperature.....	-20°C ~ +60°C
Storing Temperature.....	-30°C ~ +80°C
Operating Humidity.....	45%~80%RH
Storing Humidity.....	60%~90%RH

## Notice:

When the unit is operated to extremes, such as with maximum power output for a long time, or the temperature is over 70°C, it will enter heat protection mode, the volume will be reduced automatically. This is normal.

# Specifications

---

## Supported Formats:

- USB or memory file format: FAT16,FAT32
- Mp3 bit rate(date rate): 32-320 Kbps and variable bit rate
- Directory nesting up to a maximum of 8 levels
- Number of albums/folders: maximum 99
- Number of tracks/titles: maximum 999
- ID3 tag v2.0 or later
- File name in Unicode UTF8(maximum length:128 bytes)

## Unsupported Formates:

- Empty albums:an empty album is an album that does not contain MP3 files,and is not be shown in the display.
- Unsupported file formats are skipped.For example,Word documents(.doc) or Mp3 files with extension.dlf are ignored and not played.
- AAC,WAV,PCM audio files

## Supported MP3 Disc Format:

- ISO9660,Joliet
- Maximum title number: 512(depending on file name length)
- Maximum album number: 255
- Supported sampling frequencies: 32kHz,44.1kHz,48kHz
- Supported Bit-rates: 32-320Kbps and variable bit rate

## Supported Video Formats:

- MPEG
- RMVB

# Troubleshooting

What appears to be trouble is not always serious. Please check the following points before calling a service center.

Problem	Cause	Corrective action
General		
Unit can not power on	Unit fuse blown.	Install new fuse with correct rating.
	Car battery fuse blown.	Install new fuse with correct rating.
	Illegal operation	Reset the unit.
No/low audio output	Improper audio output connection.	Check wiring and correct.
	Volume set too low.	Increase volume level.
	Speakers damaged.	Replace speakers.
	Heavily biased volume balance.	Adjust the channel balance to center position.
	Speaker wiring is in contact with metal part of car.	Insulate all speaker wiring connections.
Poor sound quality or distortion	Pirated disc is in use.	Use original disc.
	Speaker power rating does not match unit.	Replace speakers.
	Wrong connections.	Check wiring and correct.
	Speaker is shorted.	Check wiring and correct.
Unit resets itself when engine is off	Incorrect connection between ACC and BATT.	Check wiring and correct.
TFT monitor		
Warning information is shown at all times	Parking break wiring is not correct.	Check wiring and correct.
Flashing image or interference appears on screen	The color system of video does not match the monitor.	Adjust the color system of the video playing back or the monitor in use.
	Pirated disc is in use.	Use original disc.
	Video cable damaged.	Replace cables.
	Improper video signal connections.	Check wiring and correct.
Disc playback		
Cannot insert disc	A disc is already inside the unit.	Eject current disc and insert new one.
Disc does not play back	Disc is warped or scratched.	Use disc in good condition.
	Disc is dirty or wet.	Clean disc with soft cloth.
	Incompatible disc is used.	Use compatible disc.
	Disc is inserted upside down.	Insert disc with label side up.
	Disc region code is not compatible with unit.	Use disc with proper region code.
PBC cannot be used during VCD playback	PBC is not available on the disc.	Use disc with PBC available.
Repeat or search function is invalid during VCD playback	PBC is on.	Turn PBC off.

# Wire Connections

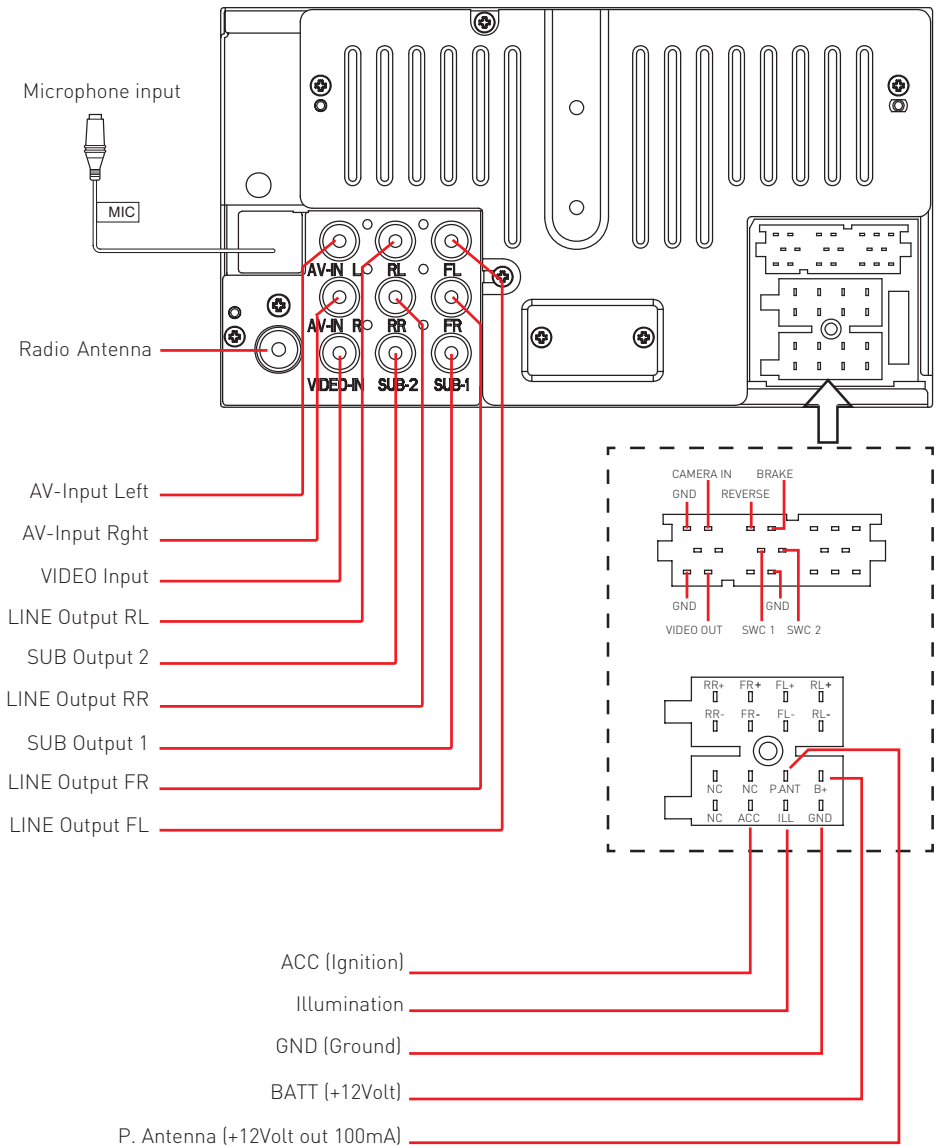



## Declaration of Conformity



Declaration of Conformity.



There are no restrictions of use.

The manufacturer Aldinet S.p.A declares that the type of radio equipment-Multimedia Navigation Receiver, model M-DL4000, brand Macrom - complies with the 2014/53 / EU Directive.

The full text of the EU Declaration of conformity is available at the following internet address:  
[www.macrom.it](http://www.macrom.it)

Aldinet S.p.A.  
Viale Colombo, 8 - 20090 Trezzano S/N (MI) Italy

**MACROM**

**ALDINET S.p.A**

Viale C. Colombo, 8 - 20090 Trezzano s/N (MI) - Italy

Tel. +39 02 484781

w w w . m a c r o m . i t