

Button Config



Menu Button

HDMI Access

Select AUX In from the OEM Source Menu.
 Hold **MENU** for 2 seconds to switch between OEM screen and Adaptiv Mini HDMI screen.
 Press and hold **MENU** to exit HDMI and return to the OEM menu.



Video In Motion Warning - 10 MPH

Double press **MENU** to disable the video in motion warning message.

Rear and Front Camera Access

From either HDMI mode or OEM mode

1. Select reverse gear to enable reverse camera
 2. Deselect reverse gear - The image will switch to after market front camera (if DIP 2 ON)
- Double Press **MENU** to manually cancel front camera or drive over 10 MPH.

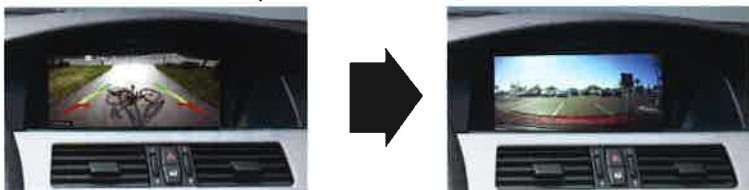

Front Camera Access

Double press **MENU** to enter the front camera screen (if DIP 2 is ON).
 Double press **MENU** to exit front camera.

View Version Number

Hold **MENU** Button for 8 seconds to enter firmware information screen



Adaptiv Mini Fitting & User Guide

ADVM-BM2
BMW CCC i-Drive with 6.6" or 8.8" Display

WWW.ADAPTIV-MULTIMEDIA.COM

Adaptiv Mini

Adaptiv Mini allows HDMI & Camera input to the OEM screen.

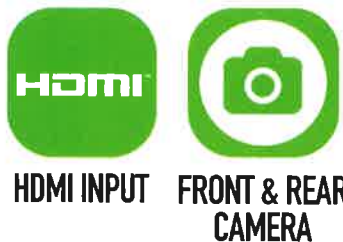

This plug and play Mini interface adds HDMI to connect your Apple or Android device, allowing you to mirror your smartphone display on the vehicle's original screen. Inputs for front and rear aftermarket cameras also come as standard with the Mini.

Application

For BMW vehicles with CCC i-Drive with 6.6" or 8.8" Display.

Kit Includes

- Adaptiv Interface
- Vehicle Harness

Prior to installation

Read the manual prior to installation. Technical knowledge is necessary for installation. The place of installation must be free of moisture and away from heat sources. Connects2 cannot be held responsible for the installation of this product.

Aux Menu Activation

(Only for vehicles that do not have factory enabled Aux input)

1. Press and hold **MENU** button for 8 seconds to enter the Adaptiv mini firmware version screen.
2. Press and hold down the iDrive control for 10 seconds to activate the Aux input.
3. Exit and lock the car for 10 minutes for the activation process to complete.

Technical Support

Connects2 want to provide a fast and suitable resolution should you encounter any technical issues. With this in mind, when contacting Connects2, try to provide as much information as possible. This will speed up the process and help us to help you.

Please use our dedicated online technical support centre: support.connects2.com

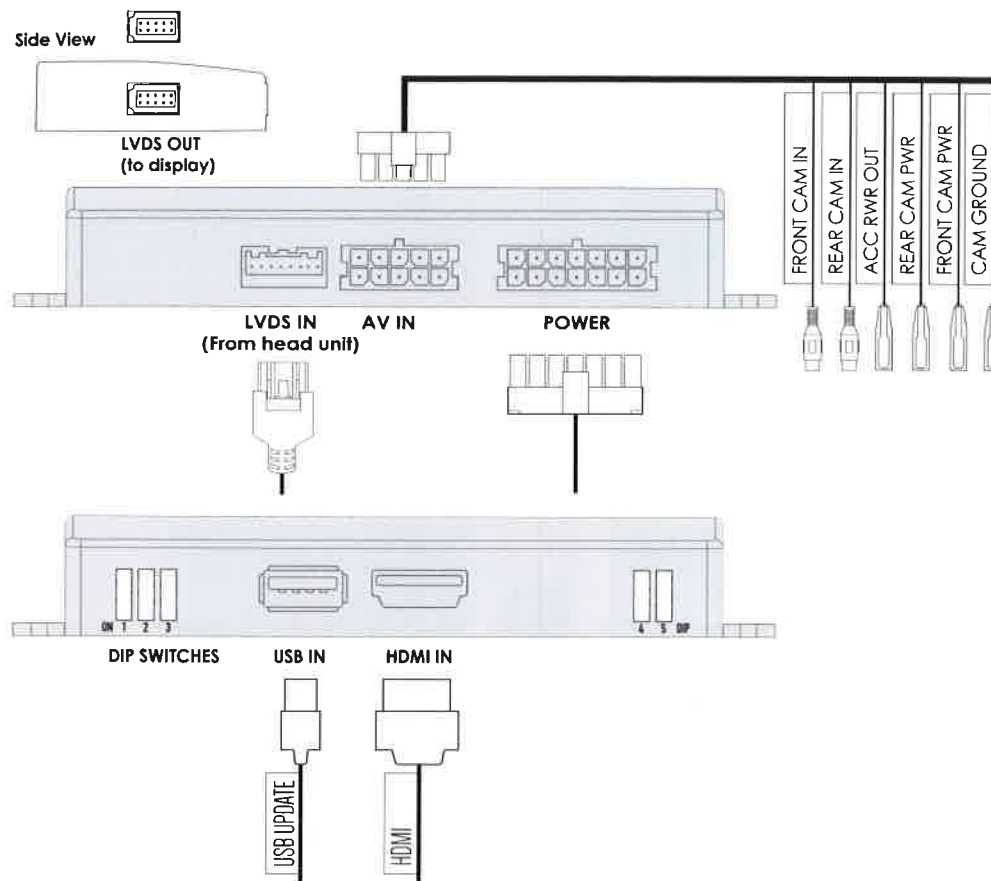

DIP SWITCH SETTINGS

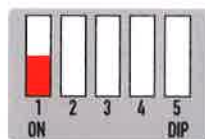

DIP 1
If the vehicle has OEM reverse camera (ON: YES OFF: NO)

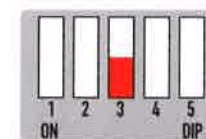

DIP 3
If the vehicle has aftermarket reverse camera (ON: YES OFF: NO)

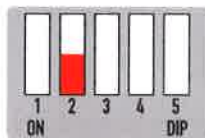

DIP 2
If the vehicle has aftermarket front camera (ON: YES OFF:NO)

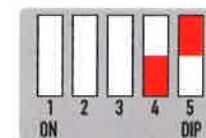

	DIP 4	DIP 5
6.6" Screen Type1	ON	OFF
6.6" Screen Type 2	ON	ON
8.8" Screen	OFF	OFF